



Vibration isolation

VIBRAX[®] – Elastomeric bearings



VIBRAX[®] DAMP C

Vibration-isolating bearings

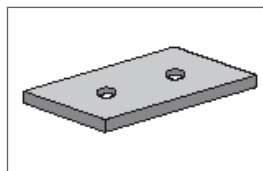
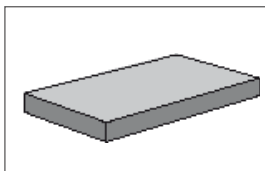



Applications and key data

General

VIBRAX®DAMP C is a profiled unreinforced deformation bearing with special properties in relation to structure-borne sound insulation and vibration isolation.

VIBRAX®DAMP C is suitable in particular for providing bearing support to prefabricated structural components, such as:

- Stairs
- Landings
- Balcony slabs

The elastomeric bearing can facilitate or compensate longitudinal and transverse movements, and rotations. VIBRAX®DAMP C consists of a high-quality elastomer mix, has a long service life and is maintenance-free.

Structural positioning of the bearings

If an elastomeric bearing is vertically loaded, it becomes compressed and its side-walls bulge outwards. The positioning of the bearing must allow this bulging, and ensure that the bulged bearing still rests completely within the reinforced area of the substructure (see Figure 1). At maximum loading, transverse deformation of $r \leq 10$ mm can be expected.

Function

- Damping bearing for prefabricated concrete elements, combating the transmission of vibrations and structure-borne noise

Permissible pressure

- ≤ 5 N/mm²

Range of application

- 1 - 4 N/mm²

Damping performance

- ≤ 27 dB at an excitation of 100 Hz

Materials

- Natural rubber (NR)
- Density approx. 1,250 kg/m³
- Hardness 41 ± 5 IRHD

Bearing shapes

- Any dimensions up to 1.20 m x 1.20 m

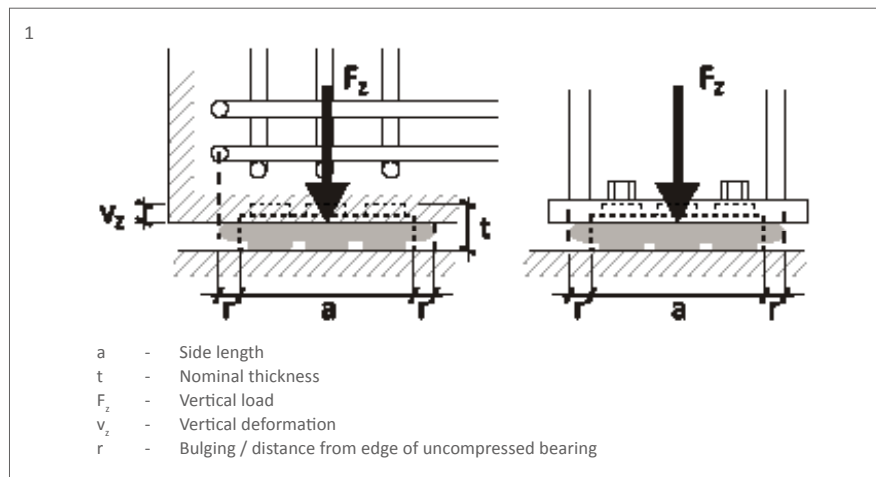

1 Correct positioning of a bearing



Design criteria

Compression curves

The load-deformation behaviour of the bearing is only marginally influenced by the roughness of the connecting surface. Very rough surfaces can allow larger deflections than smooth surfaces, because the material is pressed into the unevenness of the surface at high pressure.

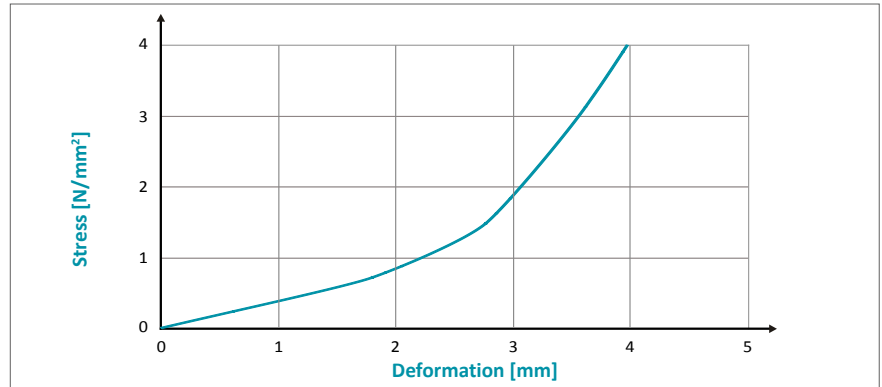

Dynamic stiffness

depends on pressure

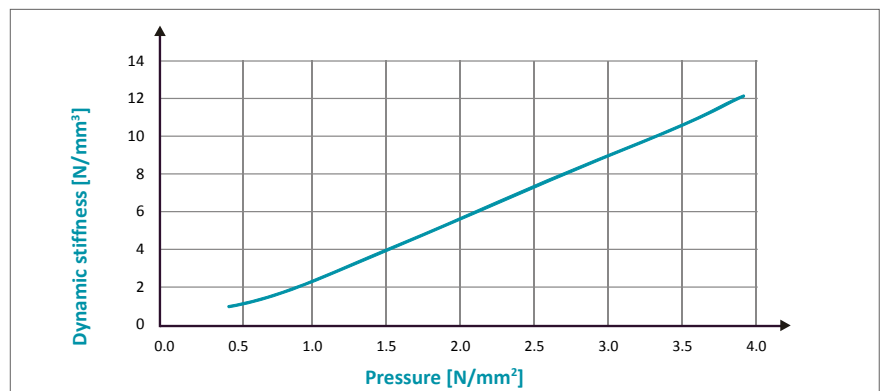

Natural frequency

depends on pressure

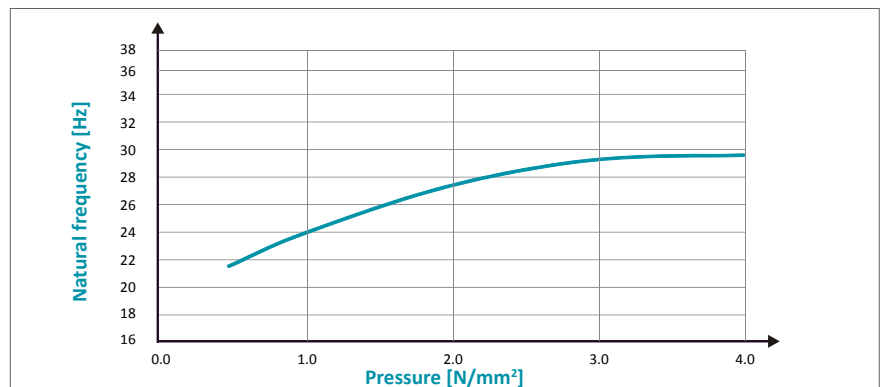

Damping performance

depending on pressure - for a disturbing frequency of 50 Hz and 100 Hz

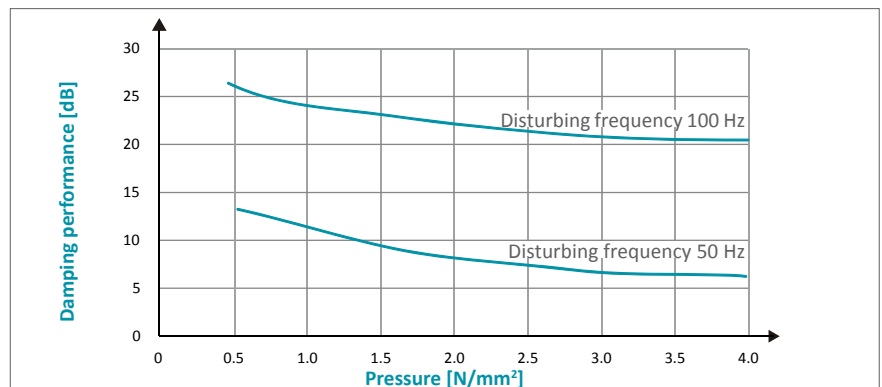



Vibration isolation

Delivery, installation and tendering

Delivery format

VIBRAX®DAMP C is available as a 1200 x 1200 mm panel, with a thickness of 12 mm. In addition to full panels, tailored pieces, with pre-drilled holes according to customer specifications, can also be supplied on request.

Assembly

Before laying of VIBRAX®DAMP C, the surface on which it is to be laid must be checked for flatness. Any protrusions must be removed, and suitable grout should be used if necessary to create a flat surface. The bearing can then be laid, ensuring that profiled surface is turned down and the substrate is clean as well as grease-free. VIBRAX®DAMP C can be simply butt-joined without any further measures.

Suggested text for tender requests

Supply and installation of unreinforced sound insulation and deformation bearings, on flat, firm surface

Brand: VIBRAX®DAMP C

Material: Natural Rubber (NR)

Permissible pressure: 10 N/mm²

Range of application as optimal sound insulation: 1 to 4 N/mm²

Bearing thickness: 12 mm

Dimensions (L x W): ... mm x ... mm

Units: Pieces.

Supplier:

mageba sa

Solistrasse 68

CH-8180 Bülach

Tel.: +41-44-872 40 50

Fax: +41-44-872 41 29

Email: hochbau@mageba.ch

www.mageba.ch

Surcharge for special designs (e.g. round bearings / with holes)

to Item ...

Brand: VIBRAX®DAMP C

According to drawing ...

tailored according to the customer's wishes

Project references



Amiens, FR



Municipal library of Stuttgart, DE



Convention Center, HK



Shopping Centre, CH



Hurghada Airport, EG



Stade de Suisse, CH

Product groups (building construction)



Bearings



Vibration isolation



Expansion joints



Special products

mageba
Switzerland www.mageba.ch

engineering connections®